

2001 STATISTICAL HANDBOOK ON

Violence against
Women and
Children



Republika ng Pilipinas

PAMBANSANG LUPON SA UGNAYANG PANG-ESTADISTIKA
(NATIONAL STATISTICAL COORDINATION BOARD)

May 2001

2001 STATISTICAL HANDBOOK ON

File
362.8302 159
N277
2001

Violence against Women and Children

cc 3371 copy 2 (08-01-01)



Prepared by the:

NATIONAL STATISTICAL COORDINATION BOARD

with funding assistance from the:

CANADIAN INTERNATIONAL DEVELOPMENT AGENCY/
NATIONAL COMMISSION ON THE ROLE OF FILIPINO WOMEN
INSTITUTIONAL STRENGTHENING PROJECT PHASE II



As reviewed and endorsed by the:

TASK FORCE TO GENERATE STATISTICS ON
VIOLENCE AGAINST WOMEN AND CHILDREN

May 2001

OTHER NSCB PUBLICATIONS

- ◆ Statistical Handbook on Women and Men in the Philippines, 1999
- ◆ Report on the Philippine Human Development Index, 1997
- ◆ Statistical Report on Children and Women, 1992
- ◆ Poverty Statistics, 1997
- ◆ National Accounts of the Philippines
- ◆ Gross Regional Domestic Product, 199-1999
- ◆ Gross Regional Domestic Expenditure, 1995-1997
- ◆ Input-Output, 1994
- ◆ Philippine Statistical Yearbook, 2000
- ◆ Dictionary of Selected Statistical Terms
- ◆ Manual on the Preparation of Statistical Project Proposals
- ◆ Philippine Standard Commodity Classification, Rev.2 1993
- ◆ Regional Social and Economic Trends (RSET), 1998
 - Region I (RSET 1)
 - Region V (RSET 5)
 - Region VI (RSET 6)
 - Region VIII (RSET 8)
 - Region IX (RSET 9)
 - Region XII (RSET 12)
- ◆ Gateway to Metro Manila, 2000
- ◆ Inventory of Ports (as of December 1998)
- ◆ Inventory of Airports (as of January 1999)
- ◆ Food Balance Sheet of the Philippines: 1997-1999
- ◆ Sixth National Convention on Statistics: 1996
- ◆ The Countryside in Figures, 2000
- ◆ 7th National Convention on Statistics Volume I and Volume II, 1999
- ◆ Asian Regional Section, International Conference on Statistical Computing, 1998
- ◆ Catalogue of Philippine Statistical Publications
- ◆ Profile of Censuses and Surveys Conducted by the Philippine Statistical System, 2000
- ◆ Directory of Statistical Services in the Philippines, 1999
- ◆ Factsheets
- ◆ NSCB Statistics Series
- ◆ Statwatch

The **Statistical Handbook on Violence against Women and Children** is a publication prepared by the **SOCIAL SECTORS DIVISION** of the **STATISTICAL PROGRAMS AND RESOURCE MANAGEMENT OFFICE, NATIONAL STATISTICAL COORDINATION BOARD**. For technical inquiries, contact the SSD at: (632) 890-9678.

Please direct your subscription and other inquiries to the:

NATIONAL STATISTICAL INFORMATION CENTER
National Statistical Coordination Board
Ground Floor Midland Buendia Bldg.,
403 Sen. Gil J. Puyat Avenue, Makati City

Tel nos.:
(632) 895-2767

Telefax nos.:
(632) 890-8456

E-mail addresses:
info@nscb.gov.ph
social@nscb.gov.ph
tb.deveza@nscb.gov.ph

The NSIC is a one-stop shop of statistical information and services in the Philippines.

This Statistical Handbook on Violence against Women and Children was developed to provide hard statistics on the prevalence of violence against women and children. It consists of two parts: (1) Violence against Women; and (2) Violence against Children.

One of the major activities of the Project on the Development of a Methodology to Generate Statistics on Violence against Women and Children (VAWC) is the compilation of available statistics on VAWC. The statistics presented in this publication are based only on the information from administrative in-take forms used by various government and non-government agencies in handling cases of VAWC. Hence, the statistics presented covers only reported cases of violence against women and children.

Cases reported in one agency, say the PNP, may have also been served and counted by the DSWD. Thus, statistics for each agency cannot be added across agencies. The absence of data on the unreported cases should be taken in the interpretation and formulation of conclusions of statistics presented in this handbook. Nevertheless, this handbook provides a valuable insight on the recent trends and patterns of the VAWC problem in the Philippines.

This statistical handbook on VAWC was made possible through the data support of the following agencies: Philippine National Police (PNP), Department of Social Welfare and Development (DSWD), Department of Labor and Employment-Bureau of Women and Young Workers (DOLE-BWYW), Commission on Human Rights-Child Rights Center (CHR-CRC), and Women's Crisis Center (WCC). We wish to acknowledge the continued invaluable support they extended to us and likewise encourage other government and non-government agencies to join us in our efforts to improve gender statistics in the Philippines.

As one of the outputs of the Project on the Development of a Methodology to Generate Statistics on Violence against Women and Children, this Handbook will be useful to the government, private, and non-government organizations in establishing a baseline from which projections could be made to improve the present situation of Filipino women and children. We wish to acknowledge with appreciation the Canadian International Development Agency Institutional Strengthening Project Phase II (CIDA-ISP II), whose

cooperation and valuable assistance extended to us made the publication of this Handbook possible. The VAWC Project is the second component of the NSCB-NCRFW Project on the Improvement of Statistics on Gender Issues with funding support from the CIDA-ISP II.

A handwritten signature in black ink, appearing to read 'ROMULO A. VIROLA'.

ROMULO A. VIROLA
Secretary General

May 2001

Cases of violence against women and children are being reported and served in various government and non-government agencies. Each of these agencies has their respective administrative forms designed to suit the information they want from their victim or clientele. From these, summary reports are prepared by these agencies for dissemination to the public and private sector.

As users of this handbook, certain issues should be followed on the interpretation of the statistics presented. Important points of this handbook are as follows:

- i. Statistics presented covers only reported cases of violence against women and children, thus, statistics for each agency cannot be added across agencies (i.e., cases reported in one agency, say the PNP, may have also been served and counted by the DSWD);
- ii. Classification of the case may vary across agencies (i.e. a case classified in PNP may be classified by the DSWD differently);
- iii. It is possible that an agency may record a reported case as one, corresponding to two victims (i.e., a rape case may have been committed against two sisters).

Although faced with certain restrictions and considerations, this handbook provides a valuable insight on the recent trends and patterns of the VAWC problem in the Philippines.

Foreword	i
Note to Users	iii
Table of Contents	v
List of Tables	vii
List of Figures	xiii
Violence Against Women	1
Statistics on Reported VAW Cases	2
Statistics on VAW Victims and Perpetrators	36
Child Abuses	57
Statistics on Reported Child Abuse Cases	58
Statistics on Child Abuse Victims and Perpetrators	92
Annexes	113
Task Force to Generate Statistics on Violence against Women and Children	115
Project Staff	117
NSCB Technical Staff	119

Table No.	Title	Page No.
1	VAW Cases Reported to the PNP by Classification of the Case, 1998-1999	2
2	VAW Cases Reported to the PNP by Classification of the Case and by Region, 1999	4
3	VAW Cases Reported to the PNP by Place of Commission, 1998-1999	6
4	VAW Cases Reported to the PNP by Place of Commission and by Region, 1999	8
5	VAW Cases Reported to the PNP by Weapons/Mean Used by the Perpetrator, 1999	10
6	VAW Cases Reported to the PNP by Weapons/Mean Used by the Perpetrator and by Region, 1999	12
7	VAW Cases Reported to the PNP by Status of the Case, 1998-1999	14
8	VAW Cases Reported to the PNP by Status of the Case and by Region, 1999	16
9	VAW Cases Reported to the PNP by Disposition/Whereabouts of the Perpetrator, 1999	18
10	VAW Cases Reported to the PNP by Disposition/Whereabouts of the Perpetrator and by Region, 1999	20
11	VAW Cases Reported to the PNP by Day of Commission, 1999	22
12	VAW Cases Reported to the PNP by Day of Commission and by Region, 1999	24

13	VAW Cases Reported to the PNP by Time of Commission, 1999	26
14	VAW Cases Reported to the PNP by Time of Commission and by Region, 1999	28
15	VAW Cases Served by WCC by Classification of the Case, 1997-1999	30
16	Women in Especially Difficult Circumstances (WEDC) Served by DSWD, 1998-1999	32
17	Women in Especially Difficult Circumstances (WEDC) Served by DSWD by Region, 1999	34
18	VAW Victims Reported to the PNP by Age Group, 1998-1999	36
19	VAW Victims Reported to the PNP by Age Group and by Region, 1999	38
20	VAW Victims Reported to the PNP by Relation to Perpetrator, 1998-1999	40
21	VAW Victims Reported to the PNP by Relation to Perpetrator and by Region, 1999	42
22	VAW Perpetrators Reported to the PNP by Age Group, 1999	44
23	VAW Perpetrators Reported to the PNP by Age Group and by Region, 1999	46
24	VAW Perpetrators Reported to the PNP by Sex, 1999	48
25	VAW Perpetrators Reported to the PNP by Sex and by Region, 1999	50
26	VAW Perpetrators Reported to the PNP by History of Substance of Abuse, 1999	52

27	VAW Perpetrators Reported to the PNP by History of Substance Abuse and by Region, 1999 ‡	54
28	Child Abuse Cases Reported to the PNP by Classification of the Case, 1998-1999	58
29	Child Abuse Cases Reported to the PNP by Classification of the Case and by Region, 1999	60
30	Child Abuse Cases Reported to the PNP by Place of Commission, 1999	62
31	Child Abuse Cases Reported to the PNP by Place of Commission and by Region, 1999	64
32	Child Abuse Cases Reported to the PNP by Weapons/Mean Used by the Perpetrator, 1999	66
33	Child Abuse Cases Reported to the PNP by Weapons/Mean Used by the Perpetrator and by Region, 1999	68
34	Child Abuse Cases Reported to the PNP by Status, 1998-1999	70
35	Child Abuse Cases Reported to the PNP by Status and by Region, 1999	72
36	Child Abuse Cases Reported to the PNP by Disposition/Whereabouts of the Perpetrator, 1999	74
37	Child Abuse Cases Reported to the PNP by Disposition/Whereabouts of the Perpetrator and by Region, 1999	76
38	Child Abuse Cases Reported to the PNP by Day of Commission, 1999	78

39	Child Abuse Cases Reported to the PNP by Day of Commission and by Region, 1999	80
40	Child Abuse Cases Reported to the PNP by Time of Commission, 1999	82
41	Child Abuse Cases Reported to the PNP by Time of Commission and by Region, 1999	84
42	Children in Especially Difficult Circumstances (CEDC) Served by DSWD, 1997-1999	86
43	Number of Human Rights Violations Handled by CHR-CRC by Clientele Type, April 1994-June 1997	88
44	Number of Human Rights Violations Handled by CHR-CRC by Clientele Type, 1999	89
45	Number of Child Workers Rescued by BWYW, 1993-1998	90
46	Child Abuse Victims Reported to the PNP by Age Group, 1998-1999	92
47	Child Abuse Victims Reported to the PNP by Age Group and by Region, 1999	94
48	Child Abuse Victims Reported to the PNP by Sex, 1999	96
49	Child Abuse Victims Reported to the PNP by Sex and by Region, 1999	98
50	Child Abuse Perpetrators Reported to the PNP by Age Group, 1999	100
51	Child Abuse Perpetrators Reported to the PNP by Age Group and by Region, 1999	102
52	Perpetrators of Child Abuse Cases Reported to the PNP by Sex, 1999	104

53	Perpetrators of Child Abuse Cases Reported to the PNP by Sex and by Region, 1999	106
54	Perpetrators of Child Abuse Cases Reported to the PNP by History of Substance Abuse, 1999	108
55	Perpetrators of Child Abuse Cases Reported to the PNP by History of Substance Abuse and by Region, 1999	110

Figure No.	Title	Page No.
1	Top Three VAW Cases Reported to the PNP, 1998-1999	3
2	Distribution of VAW Cases Reported to the PNP by Place of Commission, 1998-1999	7
3	Distribution of VAW Cases Reported to the PNP by Weapons/Mean Used by the Perpetrator, 1999	11
4	Distribution of VAW Cases Reported to the PNP by Status of the Case, 1998-1999	15
5	Distribution of VAW Cases Reported to the PNP by Disposition/Whereabouts of the Perpetrator, 1999	19
6	Distribution of VAW Cases Reported to the PNP by Day of Commission, 1999	23
7	Distribution of VAW Cases Reported to the PNP by Time of Commission, 1999	27
8	Top Three VAW Cases Served by WCC by Classification of the Case, 1997-1999	31
9	Top Three VAW Cases Served by DSWD, 1998-1999	33
10	Distribution of VAW Victims Reported to the PNP by Age Group, 1998-1999	37
11	Distribution of VAW Victims Reported to the PNP by Relation to Perpetrator, 1998-1999	41
12	Distribution of VAW Perpetrators Reported to the PNP by Age Group, 1999	45

13	Distribution of VAW Perpetrators Reported to the PNP by Sex, 1999	49
14	Distribution of VAW Perpetrators Reported to the PNP by History of Substance Abuse, 1999	53
15	Top Three Child Abuse Cases Reported to the PNP, 1998-1999	59
16	Distribution of Child Abuse Cases Reported to the PNP by Place of Commission, 1999	63
17	Distribution of Child Abuse Cases Reported to the PNP by Weapons/Means Used by the Perpetrator, 1999	67
18	Distribution of Child Abuse Cases Reported to the PNP by Status, 1998-1999	71
19	Distribution of Child Abuse Cases Reported to the PNP by Disposition/Whereabouts of the Perpetrator, 1999	75
20	Distribution of Child Abuse Cases Reported to the PNP by Day of Commission, 1999	79
21	Distribution of Child Abuse Cases Reported to the PNP by Time of Commission, 1999	83
22	Distribution of Children in Especially Difficult Circumstances (CEDC) Served by DSWD, 1997-1999	87
23	Number of Child Workers Rescued by BWYW, 1993-1998	91
24	Distribution of Child Abuse Victims Reported to the Police by Age Group, 1999	93
25	Distribution of Child Abuse Victims Reported to the PNP by Sex, 1999	97

26	Distribution of Child Abuse Perpetrators Reported to the PNP by Age Group, 1999	101
27	Distribution of Perpetrators of Child Abuse Cases Reported to the PNP by Sex, 1999	105
28	Distribution of Perpetrators of Child Abuse Cases Reported to the PNP by History of Substance Abuse, 1999	109

**VIOLENCE
AGAINST
WOMEN**

**Table 1. VAW Cases Reported to the PNP
by Classification of the Case, 1998-1999**

Classification of the Case	1998		1999	
	Number	Percent	Number	Percent
Physical Injuries	2633	40.4	2413	35.2
Rape	1054	16.2	946	13.9
Wife Battering	588	8.6
Acts of Lasciviousness	426	6.5	586	8.5
Maltreatment	290	4.2
Threats	290	4.2
Attempted Rape	25	0.4	257	3.7
Concubinage	147	2.1
Sexual Harassment	151	2.3	80	1.2
Malicious Mischief	74	1.1
Unjust Vexation	57	0.8
Qualified Seduction	49	0.7
Abduction	49	0.7
White Slave Trade	43	0.6
Illegal Recruitment	39	0.6
Sex Trafficking	24	0.3
Others*	2229	34.2	928	13.5
Total	6518	100	6860	100

* includes other gender-based crimes

Source: Philippine National Police

Figure 1. Top Three VAW Cases Reported to the PNP, 1998-1999

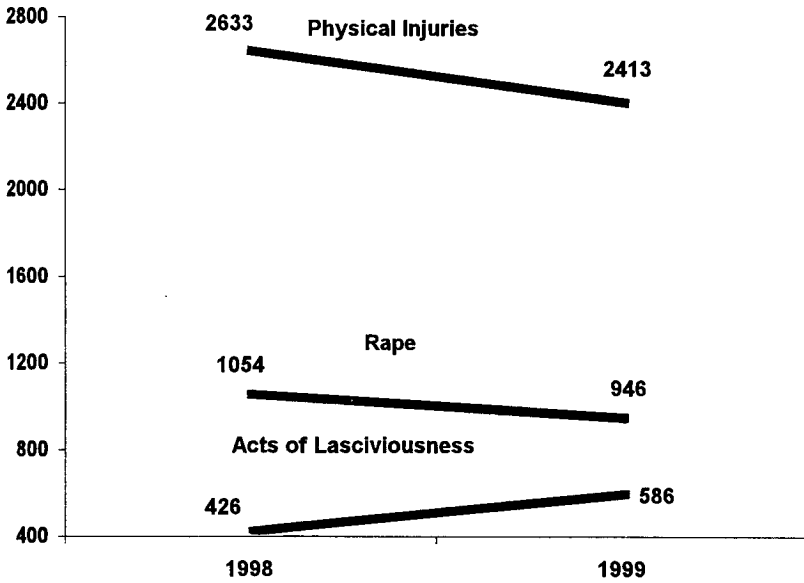

Source: Philippine National Police

**Table 2. VAW Cases Reported to the PNP
by Classification of the Case and by Region, 1999**

Classification of the Case	TOTAL	XII	X	VII	XI	VI
Physical Injuries	2413	383	360	346	260	256
Rape	946	54	33	79	129	61
Battered Wife	588	28	48	143	36	126
Acts of Lasciviousness	586	34	21	68	32	52
Maltreatment	290	12	7	7	6	70
Threats	290	39	30	31	35	23
Attempted Rape	257	32	9	26	18	22
Concubinage	147	13	22	9	6	8
Sexual Harassment	80	5	7	23	6	15
Malicious Mischief	74	10	7	14	9	5
Unjust Vexation	57	6	3	2	5	...
Qualified Seduction	49	9	2	...	5	1
Abduction	49	8	2	6	4	2
White Slave Trade	43	8	4	2	3	2
Illegal Recruitment	39	8	5	4	1	1
Sex Trafficking	24	5	2	...	2	1
Others*	928	117	101	68	105	85
Total	6860	388	363	482	402	474

* includes other gender-based crimes

Source: Philippine National Police

NCR	CAR	VIII	III	IX	IV	V	I	XIII	II	ARMM
214	128	104	83	77	74	59	38	16	8	7
104	26	32	90	25	130	58	80	7	32	6
37	83	10	6	26	11	11	11	10	1	1
108	19	27	48	14	69	28	43	4	15	4
26	22	55	5	54	7	7	3	2	7	...
21	32	6	19	13	17	10	8	2	1	3
26	3	8	22	6	36	15	7	2	20	5
18	15	1	10	6	12	5	11	8	1	2
1	2	2	4	3	4	2	2	...	3	1
12	5	1	2	5	1	1	2
14	19	1	...	1	4	2
13	6	...	2	4	2	3	2	...
5	2	3	4	4	3	2	3	1
3	5	2	...	2	4	8
6	9	2	1	1	...	1
2	2	...	1	8	1
124	38	24	71	63	44	13	41	6	10	18
520	288	172	284	236	344	162	211	92	45	44

**Table 3. VAW Cases Reported to the PNP
by Place of Commission, 1998-1999**

Place of Commission	1998		1999	
	Number	Percent	Number	Percent
House	539	64.5	2963	64.2
Office/School	27	3.2	161	3.5
Uninhabited Place	121	2.6
Motel/Hotel/Inn	20	2.4	120	2.6
Rice Field	72	1.6
Abandoned Place	36	0.8
Public Place	129	15.4
Others*	121	14.5	1151	24.8
Total	836	100	4644	100

Note: 1998 and 1999 totals do not add up to 6518 and 6860, respectively, due to some VAW cases whose place of commission were not stated in the in-take forms.

* includes those committed inside vehicles, etc.

Source: Philippine National Police

Figure 2. Distribution of VAW Cases Reported to the PNP by Place of Commission, 1998-1999
(In Percent)

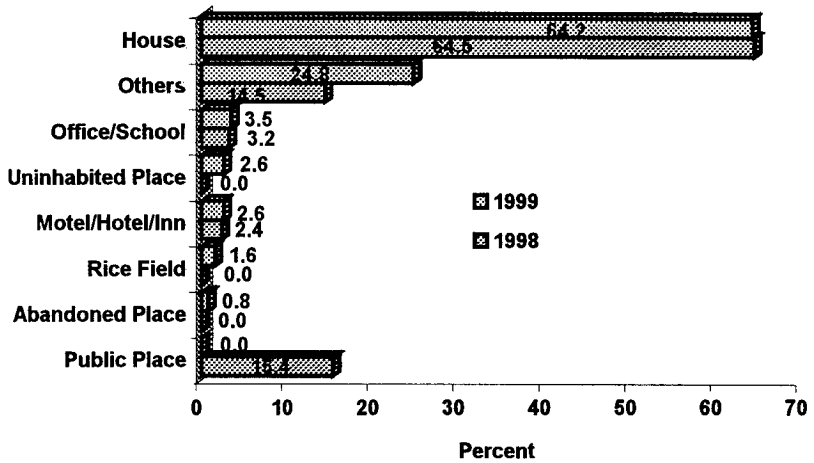

Source: Philippine National Police

**Table 4. VAW Cases Reported to the PNP
by Place of Commission and by Region, 1999**

Place of Commission	TOTAL	VII	NCR	XI	XII	VI
House	2983	433	398	310	295	244
Office/School	161	10	42	17	16	11
Uninhabited Place	121	6	3	1	8	23
Motel/Hotel/Inn	120	12	26	8	12	3
Ricefield	72	2	1	5	4	7
Abandoned	36	2	4	1	2	7
Others*	1151	104	160	131	145	87
Total	4644	569	634	473	482	362

Note: Totals do not add up to 6860 due to some VAW cases whose place of commission were not stated in the in-take forms.

* includes those committed inside vehicles, etc.

Source: Philippine National Police

X	IV	III	CAR	V	VIII	I	IX	II	ARMM	XIII
223	205	202	158	136	135	76	72	46	26	24
6	15	8	5	2	6	2	3	16	2	...
43	10	8	8	4	5	1	1
8	13	10	15	3	3	1	2	3	...	1
...	3	1	20	3	22	3	1	...
3	5	1	7	4
91	112	46	75	35	55	61	27	6	13	3
374	363	276	288	187	221	143	104	76	43	29

Table 5. VAW Cases Reported to the PNP by Weapons/Mean Used by the Perpetrator, 1999

Weapons/Mean Used	1999	
	Number	Percent
Hands/Feet/Fists	2561	65.5
Bladed Instrument	462	11.8
Blunt Instrument	189	4.8
Firearm	120	3.1
Others*	575	14.7
Total	3907	100

Note: Total does not add up to 6860 due to some VAW cases whose weapons/means used by the perpetrator were not stated in the in-take forms.

* includes poison or other toxic substance

Source: Philippine National Police

**Figure 3. Distribution of VAW Cases Reported to the PNP
by Weapons/Mean Used by the Perpetrator, 1999
(In Percent)**

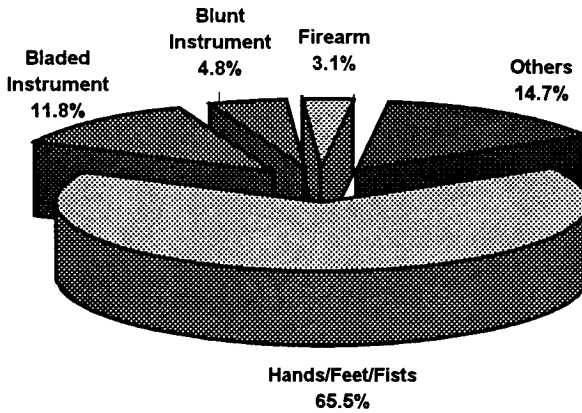

Source: Philippine National Police

Table 6. VAW Cases Reported to the PNP
by Weapons/Mean Used by the Perpetrator
and by Region, 1999

Weapons/Mean Used	TOTAL	NCR	VII	XI	X	VI
Hands/Feet/Fists	2561	385	353	280	270	234
Bladed Instrument	462	28	54	30	21	46
Blunt Instrument	189	22	15	7	7	16
Firearm	120	6	15	11	3	9
Others	575	54	61	37	38	133
Total	3907	495	498	365	338	438

Note: Totals do not add up to 6860 due to some VAW cases whose weapons/means used by the perpetrator were not stated in the in-take forms.

* includes poison or other toxic substance

Source: Philippine National Police

CAR	IV	XII	III	VIII	IX	V	I	II	XIII	ARMY
185	146	144	121	115	101	83	69	49	17	9
7	56	55	48	28	11	32	28	7	4	7
9	56	15	7	6	4	8	8	6	1	2
3	11	11	13	4	3	4	13	7		7
41	52	11	45	21	12	20	26	10	7	7
245	321	236	234	174	131	147	144	79	29	32

**Table 7. VAW Cases Reported to the PNP
by Status of the Case, 1998-1999**

Status of the Case	1998		1999	
	Number	Percent	Number	Percent
Filed in Court	1730	30.6	2204	38.2
Referred to DSWD/ Brgy /Police	1165	20.6	1325	23.0
Settled	1353	23.9	1274	22.1
Pending Investigation	981	17.4	611	10.6
Closed/Dropped	322	5.7	233	4.0
Dismissed	84	1.5
Decided	63	1.1	40	0.7
Record Purpose	39	0.7
Total	5653	100	5771	100

Note: 1998 and 1999 totals do not add up to 6518 and 6860, respectively, due to some VAW cases whose status of the case were not stated in the in-take forms.

Source: Philippine National Police

Figure 4. Distribution of VAW Cases Reported to the PNP by Status of the Case, 1998-1999
(In Percent)

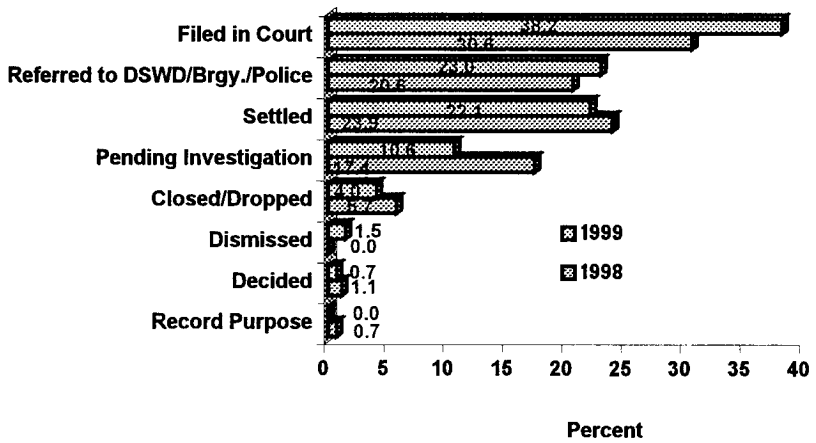

Source: Philippine National Police

**Table 8. VAW Cases Reported to the PNP
by Status of the Case and by Region, 1999**

Status of the Case	TOTAL	NCR	IV	III	XII	I
Filed in Court	2204	379	286	195	173	169
Referred to DSWD/ Brgy./Police	1325	145	31	25	92	13
Settled	1274	72	20	30	184	24
Pending Investigation	611	60	15	36	49	25
Closed/Dropped	233	9	3	18	60	1
Dismissed	84	5	1	1	16	...
Decided	40	7	2	...	9	1
Total	5771	677	358	305	583	233

Note: Totals do not add up to 6860 due to some VAW cases whose status of the case were not stated in the in-take forms.

Source: Philippine National Police

VI	VII	XI	X	CAR	V	VIII	II	IX	XIII	ARMM
169	162	156	120	93	92	79	53	49	15	14
89	154	141	247	162	40	82	13	66	13	12
270	184	149	137	33	26	35	5	81	6	9
72	74	91	38	28	18	27	11	51	1	15
58	20	19	13	12	...	5	2	10	2	1
...	15	23	4	4	8	7
6	5	9	1

673	614	588	559	332	184	229	84	264	37	51
-----	-----	-----	-----	-----	-----	-----	----	-----	----	----

**Table 9. VAW Cases Reported to the PNP
by Disposition/Whereabouts of the Perpetrator, 1999**

Disposition/ Whereabouts	1999	
	Number	Percent
At large	2076	55.7
Suspect Arrested	1227	32.9
Warrant Issued	253	6.8
On Bail	169	4.5
Total	3725	100

Note: Total does not add up to 6860 due to some VAW cases whose disposition/
whereabouts of the perpetrator were not stated in the in-take forms.

Source: Philippine National Police

**Figure 5. Distribution of VAW Cases Reported to the PNP by Disposition/Whereabouts of the Perpetrator, 1999
(In Percent)**

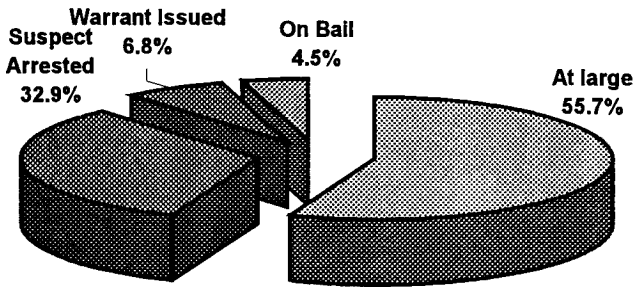

Source: Philippine National Police

**Table 10. VAW Cases Reported to the PNP
by Disposition/Whereabouts of the Perpetrator, 1999**

Disposition/ Whereabouts	TOTAL	VII	XII	NCR	VI	XI
At Large	2076	284	255	251	235	187
Suspect Arrested	1227	138	124	296	109	90
Warrant Issued	253	27	43	3	26	24
On Bail	169	15	14	14	7	15
Total	3725	464	436	564	377	316

Note: Totals do not add up to 6860 due to some VAW cases whose disposition/
whereabouts of the perpetrator were not stated in the in-take forms.

Source: Philippine National Police

IV	III	X	V	CAR	I	IX	VIII	II	XIII	ARMM
172	163	142	92	79	75	64	47	16	9	5
121	72	55	29	54	43	23	30	30	4	9
40	12	4	17	14	13	8	16	5	1	..
15	11	8	8	20	15	..	6	4	4	13
348	258	209	146	167	146	95	99	55	18	27

Statistics on Reported VAW Cases

**Table 11. VAW Cases Reported to the PNP
by Day of Commission, 1999**

Day of Commission	Number	Percent
Sunday	895	15.9
Monday	884	15.7
Wednesday	809	14.4
Thursday	783	13.9
Tuesday	781	13.9
Friday	735	13.1
Saturday	733	13.0
Total	5620	100

Note: Total may not add up to 6860 due to some VAW cases whose day of commission were not stated in the in-take forms.

Source: Philippine National Police

Figure 6. Distribution of VAW Cases Reported to the PNP by Day of Commission, 1999
(In Percent)

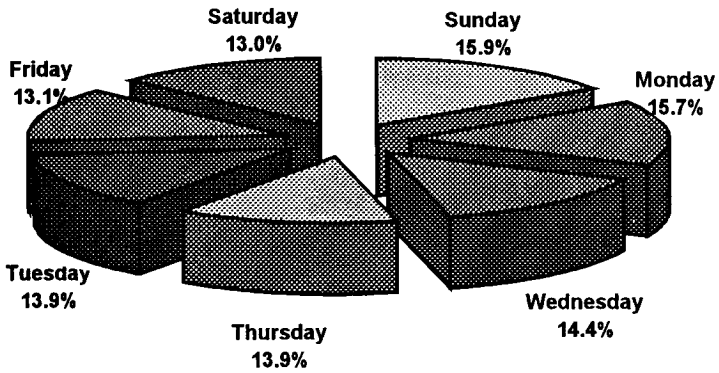

Source: Philippine National Police

**Table 12. VAW Cases Reported to the PNP
by Day of Commission and by Region, 1999**

Day of Commission	TOTAL	VII	NCR	X	VI	XI
Sunday	895	119	111	94	92	90
Monday	884	118	112	85	82	80
Wednesday	809	94	83	97	112	70
Thursday	783	79	97	65	118	72
Tuesday	781	95	84	62	93	90
Friday	735	84	98	49	80	68
Saturday	733	101	87	92	77	71
Total	5620	690	672	544	654	541

Note: Totals may not add up to 6860 due to some VAW cases whose day of commission were not stated in the in-take forms.

Source: Philippine National Police

XII	IV	CAR	III	V	VIII	IX	I	II	ARMM	XIII
82	65	56	44	32	31	29	21	15	10	4
93	58	79	38	25	34	30	17	17	10	6
84	37	54	43	32	31	27	21	12	7	5
76	48	53	45	24	40	35	7	14	5	5
70	49	54	45	18	34	36	21	17	9	4
83	42	67	41	27	34	31	12	5	10	4
70	65	45	34	24	15	28	12	6	3	3
558	364	408	290	182	219	216	111	86	54	31

Table 13. VAW Cases Reported to the PNP
by Time of Commission, 1999

Time of Commission	1999	
	Number	Percent
6PM-12MN	1774	33.7
12NN-6PM	1447	27.5
6AM-12NN	1357	25.8
12MN-6AM	681	12.9
Total	5259	100

Note: Total may not add up to 6860 due to some VAW cases whose time of commission were not stated in the in-take forms.

Source: Philippine National Police

**Figure 7. Distribution of VAW Cases Reported to the PNP by Time of Commission, 1999
(In Percent)**

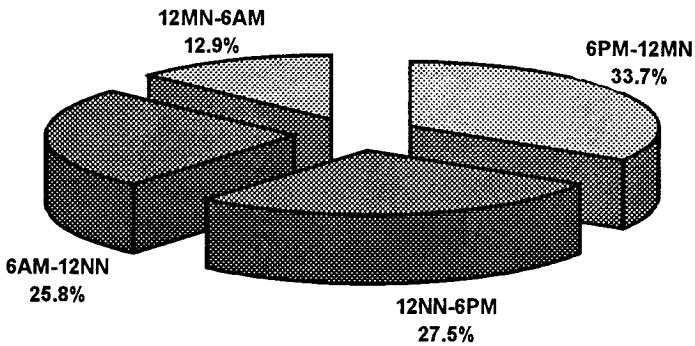

Source: Philippine National Police

**Table 14. VAW Cases Reported to the PNP
by Time of Commission and by Region, 1999**

Time of Commission	TOTAL	VII	NCR	XI	VI	CAR
6PM-12MN	1774	229	204	198	188	165
12NN-6PM	1447	175	174	115	150	102
6AM-12NN	1357	184	155	125	153	73
12MN-6AM	681	78	99	66	45	46
Total	5259	666	632	504	536	356

Note: Totals may not add up to 6860 due to some VAW cases whose time of commission were not stated in the in-take forms.

Source: Philippine National Police

IV	XII	III	X	IX	VIII	V	I	ARMM	II	XIII
126	126	121	108	104	83	42	29	21	20	10
125	164	83	70	78	75	41	44	13	24	14
71	163	90	77	64	74	32	45	25	14	12
68	60	42	64	36	26	19	21	1	8	2
390	513	336	319	282	258	134	139	60	66	38

Table 15. VAW Cases Served by WCC
by Classification of the Case , 1997-1999

Classification of the Case	Number			% Increase	
	1997	1998	1999	97-98	98-99
Wife Battering	235	430	365	83.0	-15.1
Rape/Incest	48	128	51	166.7	-60.2
Incestuous Rape	36	n.a.	n.a.
Sexual Harassment	8	11	8	37.5	-27.3
Child Abuse related to Cases of Wife Battering	...	12	8	n.a.	-33.3
Sex Trafficking/Prostitution	4	6	7	50.0	16.7
Forced Pregnancy	4	n.a.	n.a.
Attempted Rape	...	2	2	n.a.	0.0
Battering by Women	4	n.a.	n.a.
Qualified Seduction	2	n.a.	n.a.
Significant Others (mostly children of battered women)	...	57	65	n.a.	14.0
Others*	...	13	26	n.a.	100.0
Total	301	659	572	118.9	-13.2

Note: n.a. - not applicable

* Others refer to other cases of battering, e.g. girlfriends, abandonment, financial support, pregnancy problem, street children, missing daughter, homelessness, stowaway, difficult relationship with the boyfriend and family members, homelessness and labor-related.

Source: Women's Crisis Center

Figure 8. Top Three VAW Cases Served by WCC by Classification of the Case , 1997-1999

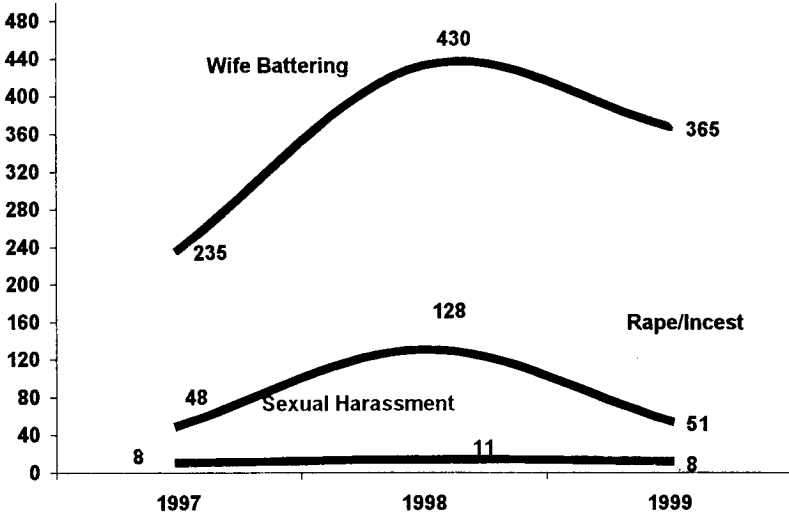

Source: Women's Crisis Center

Table 16. Women in Especially Difficult Circumstances (WEDC) Served by DSWD, 1998-1999

Classification of the Case	1998		1999	
	Number	Percent	Number	Percent
Physically Abused/ Maltreated/Battered	4083	54.6	3440	44.3
Victims of Trafficking	512	6.9	1344	17.3
Sexually Abused	1076	14.4	1205	15.5
<i>Rape</i>	<i>af</i>	<i>af</i>	905	75.2
<i>Incest</i>	<i>af</i>	<i>af</i>	294	24.4
<i>Acts of Lasciviousness</i>	<i>af</i>	<i>af</i>	6	0.5
Involuntary Prostitution	231	3.1	239	3.1
Illegal Recruitment	198	2.6	119	1.5
In Detention	52	0.7	60	0.8
Armed Conflict	92	1.2	53	0.7
Others*	1230	16.5	1303	16.8
Total	7474	100	7763	100

Note: *af* - Data not available.

* includes strandeers, abandoned and emotionally distressed/abused/disturbed women

Source: Department of Social Welfare and Development

Figure 9. Top Three WEDC Cases Served by DSWD, 1998-1999

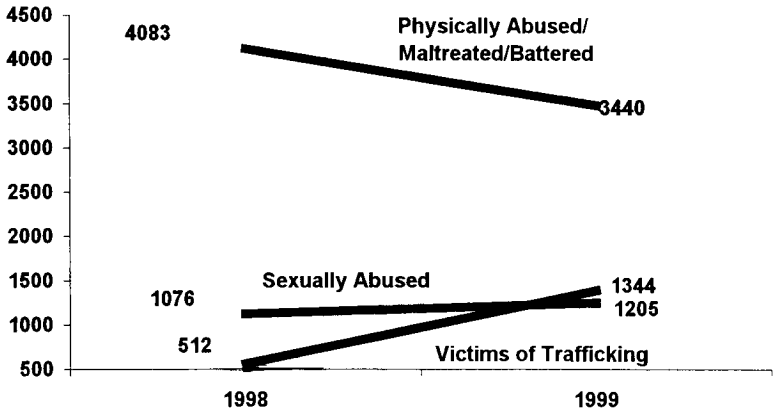

Source: Department of Social Welfare and Development

Table 17. Women in Especially Difficult Circumstances
(WEDC) Served by DSWD by Region, 1999

Classification of the Case	TOTAL	VII	IX	IV	III	X
Physically Abused/ Maltreated/Battered	3440	629	529	264	260	260
Victims of Trafficking	1344	13	97	100	5	231
Sexually Abused	1205	118	85	110	95	64
<i>Rape</i>	905	98	68	79	67	43
<i>Incest</i>	294	19	17	31	27	21
<i>Acts of Lasciviousness</i>	6	1	1	...
Involuntary Prostitution	239	...	7	2	20	6
Illegal Recruitment	119	17	11	3	9	5
In Detention	60	2	6	3	4	...
Victims of Armed Conflict	53	...	6	...	3	...
Others*	1303	299	8	38
Total	7763	1076	326	482	404	663

* includes strandeers, abandoned and emotionally
distressed/abused/disturbed women

Source: Department of Social Welfare and Development

II	I	NCR	XII	V	CAR	XI	VI	VIII	XIII
250	242	233	190	183	170	133	53	29	15
154	59	...	306	94	154	0	105	0	26
98	69	106	74	41	85	152	35	55	18
62	48	88	60	29	77	128	23	26	9
33	20	18	14	12	8	24	12	29	9
3	7
27	48	68	49	...	3	4	5
1	38	17	9	...	2	2	1	3	1
5	1	10	8	5	...	8	...	8	...
2	0	...	27	2	...	12	1
...	48	428	15	459	...	8	...
537	505	968	752	325	499	322	200	103	78

**Table 18. VAW Victims Reported to the PNP
by Age Group, 1998-1999**

Age Group of the Victim	1998		1999	
	Number	Percent	Number	Percent
18-25	1184	35.2	2001	33.7
26-30	615	18.3	1074	18.1
31-35	514	15.3	845	14.2
36-40	449	13.3	756	12.7
41-45	254	7.5	451	7.6
46-50	157	4.7	320	5.4
51-55	70	2.1	202	3.4
56-60	78	2.3	127	2.1
61 and above	44	1.3	162	2.7
Total	3365	100	5938	100

Note: 1998 and 1999 totals may not add up to 6518 and 6860, respectively, due to some VAW cases whose age of the victim were not stated in the in-take forms.

Source: Philippine National Police

**Figure 10. Distribution of VAW Victims Reported to the PNP by Age Group, 1998-1999
(In Percent)**

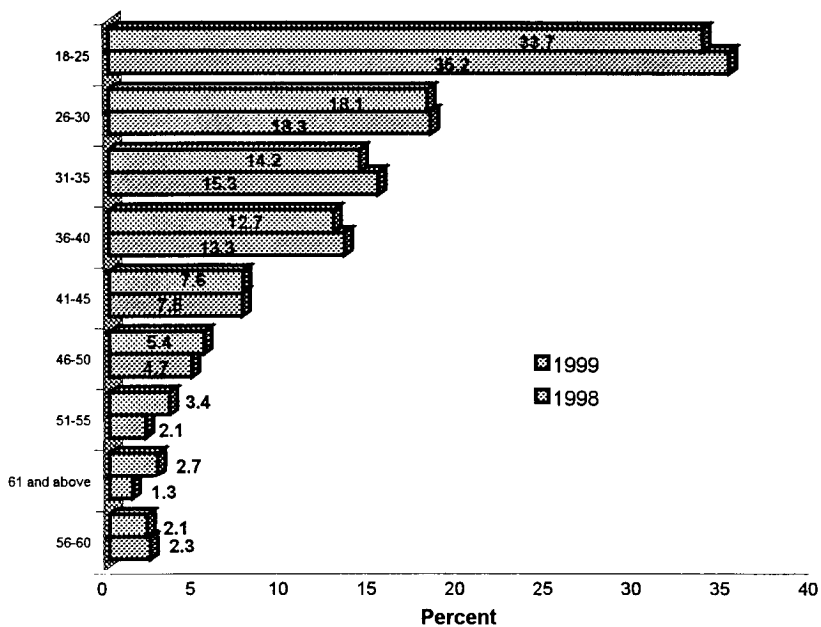

Source: Philippine National Police

Table 19. VAW Victims Reported to the PNP
by Age Group and by Region, 1999

Age Group of the Victim	TOTAL	NCR	VII	XII	VI	XI
18-25	2001	241	219	211	189	178
26-30	1074	139	132	106	107	100
31-35	845	101	113	96	100	82
36-40	756	87	89	83	93	65
41-45	451	38	58	44	60	53
46-50	320	30	34	36	40	30
51-55	202	23	17	20	23	28
61 and above	162	15	18	17	15	23
56-60	127	13	20	16	10	13
Total	5938	687	700	629	637	572

Note: Totals may not add up to 6860 due to some VAW cases whose age of the victim were not stated in the in-take forms.

Source: Philippine National Police

Statistics on VAW Victims and Perpetrator

X	IV	CAR	III	I	VIII	IX	V	II	ARMM	XIII
169	150	143	107	100	80	78	66	40	26	4
136	64	65	74	30	42	36	20	11	6	6
83	49	66	35	26	33	23	25	6	3	4
82	43	62	28	36	24	24	12	15	9	4
48	21	38	23	10	21	22	11	4	2	...
32	18	24	16	11	18	16	11	2	...	2
22	9	20	8	9	4	10	7	2
15	5	11	8	7	12	7	7	...	1	1
3	6	8	7	5	6	11	7	1	...	1
590	365	435	306	234	240	227	166	81	47	22

**Table 20. VAW Victims Reported to the PNP
by Relation to Perpetrator, 1998-1999**

Perpetrator	1998		1999	
	Number	Percent	Number	Percent
No Relation	556	55.3	2693	48.7
Husband	275	27.4	1530	27.6
Relative	77	7.7	637	11.5
Live-in	58	5.8	422	7.6
Father	21	2.1	104	1.9
Boyfriend	8	0.8	64	1.2
Stepfather	9	0.9	38	0.7
Grandparents	25	0.5
Mother	1	0.1	22	0.4
Total	1005	100	5535	100

Note: 1998 and 1999 totals may not add up to 6518 and 6860, respectively, due to some VAW cases whose victim's relation to the perpetrator were not stated in the in-take forms.

Source: Philippine National Police

Figure 11. Distribution of VAW Victims Reported to the PNP by Relation to Perpetrator, 1998-1999
(In Percent)

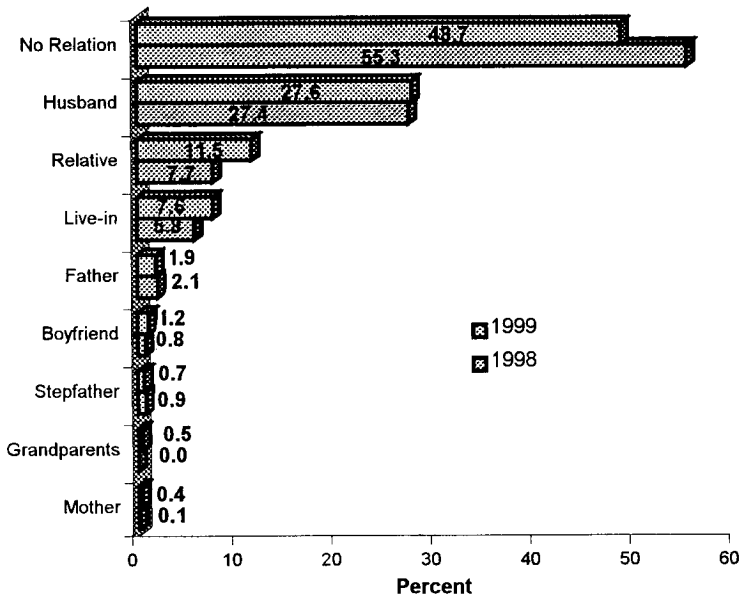

Source: Philippine National Police

Table 21. VAW Victims Reported to the PNP
by Relation to Perpetrator and by Region, 1999

Perpetrator	TOTAL	NCR	XII	XI	X	IV
No Relation	2693	359	317	259	254	251
Husband	1530	127	156	184	129	55
Relative	637	78	98	64	67	28
Live-in	422	59	55	47	36	12
Father	104	13	8	4	9	15
Boyfriend	64	6	4	6	...	10
Stepfather	38	5	3	1	4	8
Grandparents	25	2	3	2
Mother	22	1	3	...	14	...
Total	5535	650	647	565	513	381

Note: Totals may not add up to 6860 due to some VAW cases whose victim's relation to the perpetrator were not stated in the in-take forms.

Source: Philippine National Police

VI	VII	III	CAR	I	V	VIII	IX	II	ARMM	XIII
239	199	185	167	150	90	90	67	48	11	7
179	289	69	115	2	38	63	96	8	6	14
69	59	29	32	34	21	19	18	14	6	1
37	53	26	31	9	10	33	6	6	1	1
6	9	8	6	12	7	4	1	2
2	8	3	5	2	3	7	3	3	2	...
1	4	3	1	1	5	1	...	1
2	7	...	4	2	...	3
...	2	...	1	1
535	623	323	365	210	178	218	191	52	26	28

Table 22. VAW Perpetrators Reported to the PNP by Age Group, 1999

Age Group of the Perpetrator	1999	
	Number	Percent
18-25	1298	18.9
26-30	1030	15.0
31-35	873	12.7
36-40	806	11.7
41-45	467	6.8
46-50	286	4.2
51-55	172	2.5
56-60	121	1.8
61 and above	124	1.8
Total	5177	76

Note: Total may not add up to 6860 due to some VAW cases whose age of the perpetrator were not stated in the in-take forms.

Source: Philippine National Police

Figure 12. Distribution of VAW Perpetrators Reported to the PNP by Age Group, 1999
(In Percent)

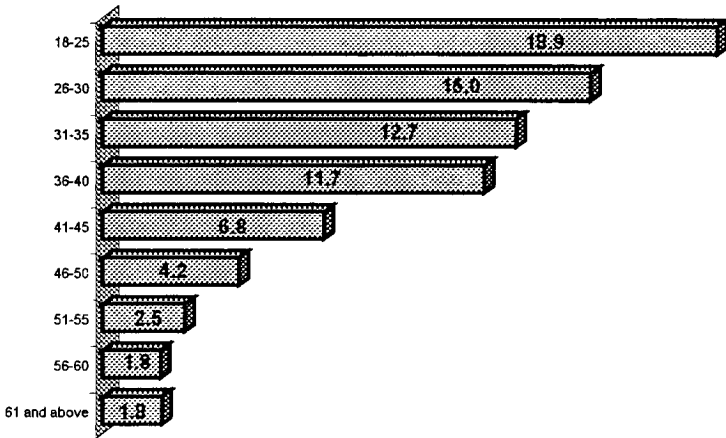

Source: Philippine National Police

Table 23. VAW Perpetrators Reported to the PNP by Age Group and by Region, 1999

Age Group of the Perpetrator	TOTAL	XII	VII	NCR	X	VI
18-25	1298	169	154	135	126	124
26-30	1030	118	116	130	119	84
31-35	873	99	117	92	94	83
36-40	806	61	115	109	83	97
41-45	467	40	66	50	42	51
46-50	286	21	27	30	43	31
51-55	172	13	26	14	17	13
56-60	124	15	10	10	8	13
61 and above	121	20	16	6	12	13
Total	5177	556	647	576	644	509

Note: Totals may not add up to 6860 due to some VAW cases whose age of the perpetrator were not stated in the in-take forms.

Source: Philippine National Police

XI	CAR	IV	III	IX	I	VIII	V	II	ARMY	XIII
118	101	69	66	60	55	50	38	19	9	5
104	62	51	73	41	33	45	30	14	6	4
90	61	68	22	40	26	31	24	10	7	9
77	61	66	38	22	24	30	12	7	1	3
47	38	28	32	21	12	14	16	7	1	2
26	14	17	18	13	17	16	8	3	1	1
15	12	12	11	9	15	6	5	1	...	3
8	3	24	8	5	6	6	3	4	...	1
9	8	10	7	8	3	4	2	2	1	...
494	360	345	275	219	191	202	108	67	26	26

**Table 24. VAW Perpetrators Reported
to the PNP by Sex, 1999**

Sex of Perpetrator	1999	
	Number	Percent
Male	5282	86.3
Female	838	13.7
Total	6120	100

Note: Total may not add up to 6860 due to some VAW cases whose sex of the perpetrator were not stated in the in-take forms.

Source: Philippine National Police

Figure 13. Distribution of VAW Perpetrators Reported to the PNP by Sex, 1999 (In Percent)

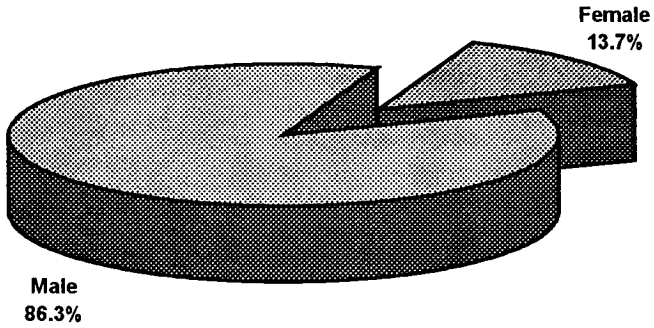

Source: Philippine National Police

**Table 25. VAW Perpetrators Reported to the PNP
by Sex and by Region, 1999**

Perpetrator	TOTAL	NCR	VI	XII	VII	XI
Male	5282	612	611	602	591	558
Female	838	70	74	111	65	64
TOTAL	6120	682	685	713	656	622

Note: Totals may not add up to 6860 due to some VAW cases whose sex of the perpetrator were not stated in the in-take forms.

Source: Philippine National Police

**Table 26. VAW Perpetrators Reported to the PNP
by History of Substance Abuse, 1999**

Substance Abuse	1999	
	Number	Percent
None	2275	57.4
Alcohol	1315	33.2
Drugs	206	5.2
Both	166	4.2
Total	3962	100

Note: Total may not add up to 6860 due to some VAW cases whose history of substance abuse of the perpetrator were not stated in the in-take forms.

Source: Philippine National Police

Figure 14. Distribution of VAW Perpetrators Reported to the PNP by History of Substance Abuse, 1999
(In Percent)

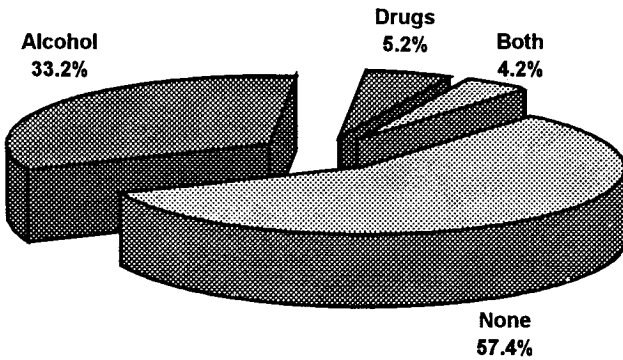

Source: Philippine National Police

**Table 27. VAW Perpetrators Reported to the PNP
by History of Substance Abuse and by Region, 1999**

Substance Abuse	TOTAL	NCR	XI	VII	XII	X
None	2275	285	264	251	239	210
Alcohol	1315	85	77	197	138	130
Drugs	206	57	22	14	9	4
Both	166	10	11	15	60	11
Total	3962	437	374	477	446	355

Note: Totals may not add up to 6860 due to some VAW cases whose history of substance abuse of the perpetrator were not stated in the in-take forms.

Source: Philippine National Police

VI	III	CAR	IV	I	V	IX	VIII	II	ARMM	XIII
203	174	130	129	106	90	69	67	32	17	9
190	71	90	93	51	49	21	86	21	5	11
39	10	8	31	1	4	...	4	...	2	1
10	3	2	18	3	7	1	4	7		4
442	268	230	271	161	150	91	161	60	24	25

**CHILD
ABUSE**

Table 28. Child Abuse Cases Reported to the PNP
by Classification of the Case, 1998-1999

Classification of the Case	1998		1999	
	Number	Percent	Number	Percent
Rape	1917	43.6	2329	38.3
Physical Injuries	688	15.7	1092	18.0
Acts of Lasciviousness	664	15.1	780	12.8
Violation of RA-7610	516	11.7	408	6.7
Incest Rape	272	4.5
Attempted Rape	139	3.2	210	3.5
Maltreatment	139	3.2	171	2.8
Missing/Abduction	106	2.4	145	2.4
Child Labor/Exploitation	58	1.3	67	1.1
Grave Threats	32	0.7	65	1.1
Neglect/Abandonment	79	1.8	48	0.8
Child Prostitution	31	0.7	30	0.5
Murder	26	0.4
Sexual Harassment	7	0.2
Others*	16	0.4	440	7.2
Total	4392	100	6083	100

* includes other forms of child abuse

Source: Philippine National Police

Figure 15. Top Three Child Abuse Cases Reported to the PNP, 1998-1999

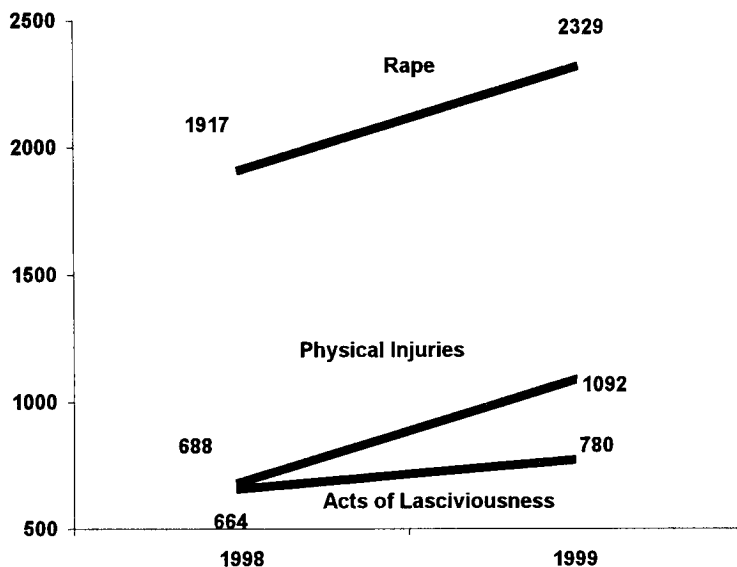

Source: Philippine National Police

Table 29. Child Abuse Cases Reported to the PNP by Classification of the Case and by Region, 1999

Classification of the Case	TOTAL	NCR	III	XII	IV	XI
Rape	2329	240	234	222	220	212
Physical Injuries	1092	88	32	165	33	141
Acts of Lasciviousness	780	182	91	70	36	55
Viol. of RA 7610-Child Abus	408	...	33	24	54	36
Incest Rape	272	17	16	43	28	26
Attempted Rape	210	13	9	43	17	17
Maltreatment	171	30	...	11	12	22
Missing Abduction	145	18	6	12	8	2
Child Labor/Exploitation	67	13	2	3	14	7
Grave Threats	65	...	1	21	...	4
Neglect/Abandonment	48	3	6	1	2	8
Child Prostitution	30	3	1	...	1	2
Murder	26	1	2	5	...	6
Others*	440	60	39	39	33	37
TOTAL	6083	668	472	659	458	575

* includes other forms of child abuse

Source: Philippine National Police

VI	V	VII	VIII	II	I	X	CAR	IX	XIII	ARMI
201	197	166	148	102	99	90	86	64	43	5
146	32	126	34	7	17	168	53	36	5	9
77	51	54	26	18	34	31	28	22	5	...
46	21	97	3	5	12	21	44	8	4	...
63	15	14	7	1	10	8	18	3	2	1
13	9	26	16	6	12	9	10	7	3	...
34	17	4	19	...	7	1	10	1	3	...
10	3	2	2	1	3	2	1	75
2	3	7	5	7	...	3	...	1
9	9	15	1	...	1	2	...	2
11	4	4	4	2	2	1	...
12	3	...	1	1	...	2	3	1
	3	1	1	...	3	3	1	...
58	15	39	13	7	14	44	20	7	8	7
682	382	555	280	150	212	388	273	230	75	24

**Table 30. Child Abuse Cases Reported to the PNP
by Place of Commission, 1999**

Place of Commission	Number of Cases	
	Number	Percent
House	2713	52.3
School	646	12.5
Motel/Hotel/Inn	228	4.4
Uninhabited Place	205	4.0
Others*	1396	26.9
Total	5188	100

Note: Total may not add up to 6083 due to child abuse cases whose place of commission were not stated in the in-take forms.

* includes those committed inside vehicles, etc.

Source: Philippine National Police

**Figure 16. Distribution of Child Abuse Cases Reported to the PNP by Place of Commission, 1999
(In Percent)**

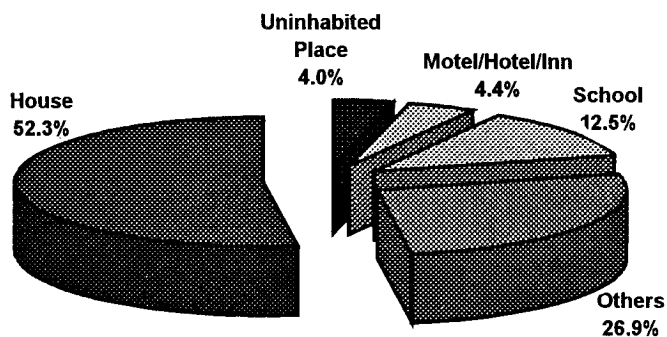

Source: Philippine National Police

**Table 31. Child Abuse Cases Reported to the PNP
by Place of Commission and by Region, 1999**

Place of Commission	TOTAL	VI	NCR	IV	XII	III
House	2713	324	309	283	271	251
School	646	33	139	19	53	58
Motel/Hotel/Inn	228	4	42	3	116	10
Uninhabited Place	205	36	9	5	56	14
Others*	1396	175	189	142	89	119
TOTAL	5185	572	688	452	585	452

Note: Totals may not add up to 6083 due to child abuse cases whose place of commission were not stated in the in-take forms.

* includes those committed inside vehicles, etc.

Source: Philippine National Police

VII	XI	V	X	CAR	I	VIII	IX	II	XIII	ARMM
250	184	168	116	115	107	104	95	90	35	11
20	168	49	24	17	2	34	16	9	4	1
19	6	7	2	7	3	3	4	2
12	7	17	12	6	1	9	7	5	5	4
146	127	68	89	40	61	61	43	26	14	7
447	492	309	243	185	174	211	165	132	58	23

**Table 32. Child Abuse Cases Reported to the PNP
by Weapons/Mean Used by the Perpetrator, 1999**

Weapons/Mean Used	1999	
	Number	Percent
Hands/Feet/Fists	2737	56.8
Bladed Instrument	601	12.5
Blunt Instrument	189	3.9
Firearm	112	2.3
Others*	1180	24.5
Total	4819	100

Note: Total may not add up to 6083 due to child abuse cases whose weapons/means used by the perpetrator were not stated in the in-take forms.

* includes poison or other toxic substance

Source: Philippine National Police

Figure 17. Distribution of Child Abuse Cases Reported to the PNP by Weapons/Means Used by the Perpetrator, 1999 (In Percent)

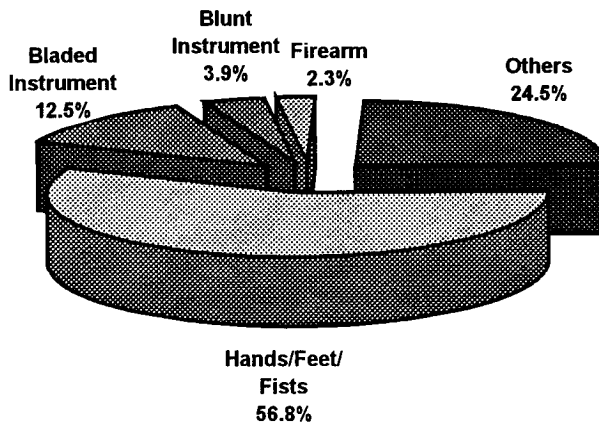

Source: Philippine National Police

**Table 33. Child Abuse Cases Reported to the PNP
by Weapons/Mean Used by the Perpetrator
and by Region, 1999**

Weapons/Mean Used	TOTAL	NCR	VI	VII	XII	XI
Hands/Feet/Fists	2737	396	364	287	277	269
Bladed Instrument	601	134	40	45	46	35
Blunt Instrument	189	25	18	13	11	7
Firearm	112	16	13	9	11	17
Others*	1180	99	112	82	203	93
Total	4819	670	547	436	548	421

Note: Total may not add up to 6083 due to child abuse cases whose weapons/means used by the perpetrator were not stated in the in-take forms.

* includes poison or other toxic substance

Source: Philippine National Police

III	X	IV	VIII	V	CAR	I	IX	II	XIII	ARMM
193	174	146	132	127	117	88	76	67	20	4
56	9	57	41	49	10	41	13	19	2	4
26	14	14	13	15	15	8	5	1	3	1
6	7	8	5	4	5	8	1	...	1	1
181	37	156	27	77	24	31	33	14	6	5
462	241	381	213	272	171	176	128	101	32	15

Table 34. Child Abuse Cases Reported
to the PNP by Status, 1998-1999

Status	1998		1999	
	Number	Percent	Number	Percent
Filed in Court	2201	59.1	2628	52.1
Pending Investigation	651	17.5	812	16.1
Settled	545	14.6	805	16.0
Ref. To Barangay/DSWD	271	7.3	597	11.8
Record Purpose	46	1.2	132	2.6
Dismissed	66	1.3
Detained	12	0.3
Total	3726	100	5040	100

Note: Total may not add up to 6083 due to child abuse cases whose status of the case were not stated in the in-take forms.

Source: Philippine National Police

Figure 18. Distribution of Child Abuse Cases Reported to the PNP by Status of the Case, 1998-1999 (In Percent)

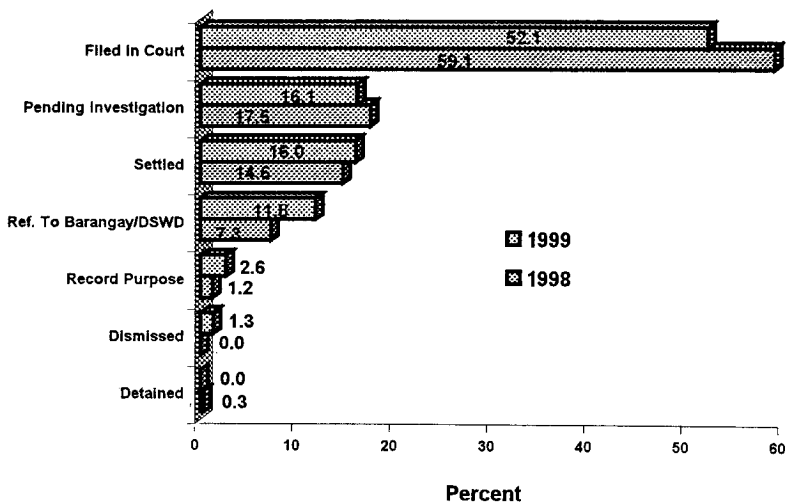

Source: Philippine National Police

**Table 35. Child Abuse Cases Reported to the PNP
by Status and by Region, 1999**

Status	TOTAL	NCR	VI	XI	IV	VII
Filed in Court	2628	505	297	238	234	209
Pending Investigation	812	44	68	85	104	70
Settled	805	43	221	58	53	104
Referred to Brgy./DSWD	597	64	34	80	32	76
Record Purpose	132	6	3	1	3	20
Dismissed	66	1	28	2	2	3
Total	5040	663	651	464	428	484

Note: Totals may not add up to 6083 due to child abuse cases whose status of the case were not stated in the in-take forms.

Source: Philippine National Police

V	XII	III	VIII	I	X	CAR	II	XIII	IX	ARMM
194	185	145	132	119	107	95	71	48	41	8
53	46	88	53	41	56	42	34	4	19	5
15	73	31	21	33	57	21	15	15	35	10
22	27	20	30	18	87	56	11	...	38	...
10	5	6	1	...	11	11	54	1
12	1	4	4	1	4	1	1	...	2	...
306	337	294	241	212	322	226	132	67	189	24

**Table 36. Child Abuse Cases Reported to the PNP
by Disposition/Whereabouts of the Perpetrator, 1999**

Disposition/ Whereabouts	1999	
	Number	Percent
Suspect Arrested	1995	47.8
At large	1502	36.0
Warrant Issued	408	9.8
On Bail	270	6.5
Total	4175	100

Note: Total may not add up to 6083 due to child abuse cases whose disposition/
whereabouts of the perpetrator were not stated in the in-take forms.

Source: Philippine National Police

Figure 19. Distribution of Child Abuse Cases Reported to the PNP by Disposition/Whereabouts of the Perpetrator, 1999

(In Percent)

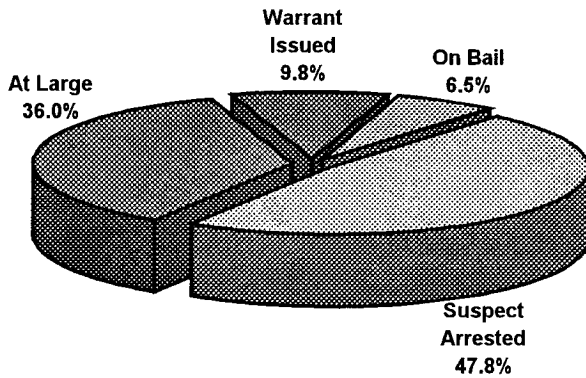

Source: Philippine National Police

**Table 37. Child Abuse Cases Reported to the PNP
by Disposition/Whereabouts of the Perpetrator
and by Region, 1999**

Disposition/ Whereabouts	TOTAL	NCR	XII	VI	III	XI
Suspect Arrested	1995	371	255	196	170	153
At large	1502	236	63	185	136	162
Warrant Issued	408	8	76	54	36	45
On Bail	270	24	129	30	13	7
Total	4175	639	523	466	355	367

Note: Totals may not add up to 6083 due to child abuse cases whose disposition/ whereabouts of the perpetrator were not stated in the in-take forms.

Source: Philippine National Police

VII	IV	V	X	II	VIII	CAR	I	IX	XIII	ARMM
147	140	118	82	78	76	62	61	49	32	5
165	110	113	61	27	67	88	13	55	14	7
22	28	59	11	6	27	10	18	6	2	...
3	24	11	...	1	8	5	9	2	4	...
337	302	301	154	112	173	165	101	112	62	12

**Table 38. Child Abuse Cases Reported to the PNP
by Day of Commission, 1999**

Day of Commission	1999	
	Number	Percent
Monday	817	15.4
Sunday	768	14.5
Wednesday	757	14.3
Saturday	752	14.2
Thursday	739	14.0
Friday	737	13.9
Tuesday	723	13.7
Total	5293	100

Note: Total may not add up to 6083 due to child abuse cases whose day of commission were not stated in the in-take forms.

Source: Philippine National Police

**Figure 20. Distribution of Child Abuse Cases Reported to the PNP by Day of Commission, 1999
(In Percent)**

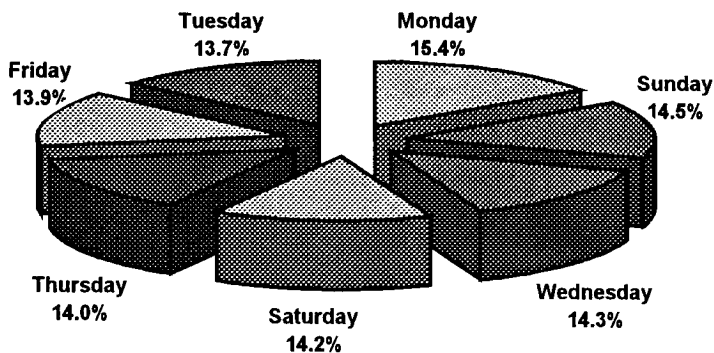

Source: Philippine National Police

**Table 39. Child Abuse Cases Reported to the PNP
by Day of Commission and by Region, 1999**

Day of Commission	TOTAL	NCR	XII	VI	IV	VII
Monday	817	103	99	93	78	75
Sunday	768	105	82	77	76	83
Wednesday	757	93	85	74	64	75
Saturday	752	113	86	80	55	65
Thursday	739	104	96	84	49	55
Friday	737	79	75	95	67	66
Tuesday	723	91	85	75	53	73
Total	5293	688	608	578	442	492

Note: Totals may not add up to 6083 due to child abuse cases whose day of commission were not stated in the in-take forms.

Source: Philippine National Police

III	XI	V	VIII	X	CAR	I	IX	II	XIII	ARMM
63	56	47	38	33	33	29	29	27	10	4
55	83	41	31	29	30	25	21	19	9	2
80	60	34	38	33	38	24	32	19	4	4
44	74	47	32	25	46	26	29	18	12	...
54	61	56	33	30	36	28	29	16	6	2
61	76	53	37	38	34	20	15	14	7	...
72	62	38	45	29	29	11	27	16	8	9
429	472	316	254	217	246	163	182	129	66	21

**Table 40. Child Abuse Cases Reported to the PNP
by Time of Commission, 1999**

Time of Commission	1999	
	Number	Percent
6PM-12MN	1656	34.1
12NN-6PM	1458	30.1
6AM-12NN	1129	23.3
12MN-6AM	607	12.5
Total	4850	100

Note: Total may not add up to 6083 due to child abuse cases whose time of commission were not stated in the in-take forms.

Source: Philippine National Police

**Figure 21. Distribution of Child Abuse Cases Reported to the PNP by Time of Commission, 1999
(In Percent)**

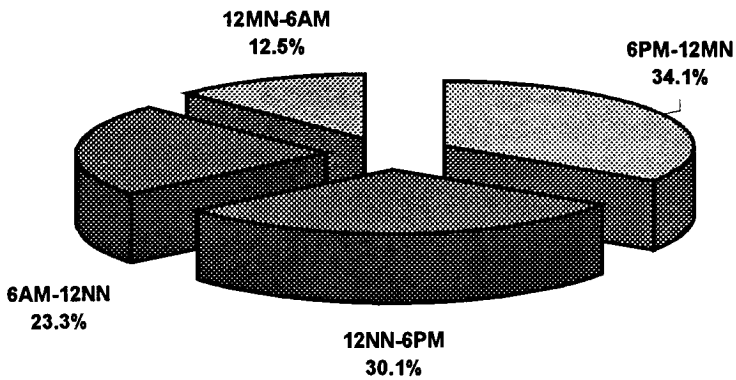

Source: Philippine National Police

**Table 41. Child Abuse Cases Reported to the PNP
by Time of Commission and by Region, 1999**

Time of Commission	TOTAL	NCR	XII	VI	XI	VII
6PM-12MN	1656	233	190	165	156	150
12NN-6PM	1458	199	157	191	124	133
6AM-12NN	1129	127	157	159	107	109
12MN-6AM	607	92	75	45	52	70
Total	4850	651	579	660	439	462

Note: Totals may not add up to 6083 due to child abuse cases whose time of commission were not stated in the in-take forms.

Source: Philippine National Police

III	V	IV	CAR	X	VIII	IX	I	II	XIII	ARMM
144	119	115	83	74	71	55	52	39	8	2
125	38	133	67	77	70	42	47	38	11	6
77	48	84	45	44	61	43	24	23	11	10
46	29	68	15	30	26	24	20	4	8	3
392	234	400	210	225	228	164	143	104	38	21

Table 42. Children in Especially Difficult Circumstances (CEDC) Served by DSWD, 1997-1999

Classification of the Case	Number			% Increase	
	1997	1998	1999	97-98	98-99
Sexually Abused	2346	3098	5289	32.1	70.1
<i>Rape/Attempted Rape</i>	1006	1710	2726	70.0	59.4
<i>Incest</i>	967	880	1912	-9.0	117.3
<i>Acts of Lasciviousness</i>	354	436	631	23.2	44.7
<i>Attempted Rape</i>	19	n.a.	n.a.
<i>Not classified</i>	...	72	...	n.a.	n.a.
Neglected	855	1910	2566	123.4	34.3
Physically Abused/Maltreated	908	1256	1784	38.3	42.0
Abandoned	1490	2032	1168	36.4	-42.5
Victims of Child Labor	25	261	560	944.0	114.6
Sexually-exploited	78	118	353	51.3	199.2
<i>Victims of Prostitution</i>	60	65	293	8.3	350.8
<i>Victims of Pedophilia</i>	15	51	41	240.0	-19.6
<i>Victims of Pornography</i>	3	1	19	-66.7	1800.0
<i>Others</i>	...	1	...	n.a.	n.a.
Child Trafficking	19	41	85	115.8	107.3
Victims of Armed Conflict	56	n.a.	n.a.
Emotionally Abused	137	n.a.	n.a.
Illegal Recruitment	16	n.a.	n.a.
Abduction	11	n.a.	n.a.
Total	5885	8716	11841	48.1	35.9

Source: Department of Social Welfare and Development

Figure 22. Top Three Cases of Children in Especially Difficult Circumstances (CEDC) Served by DSWD, 1997-1999

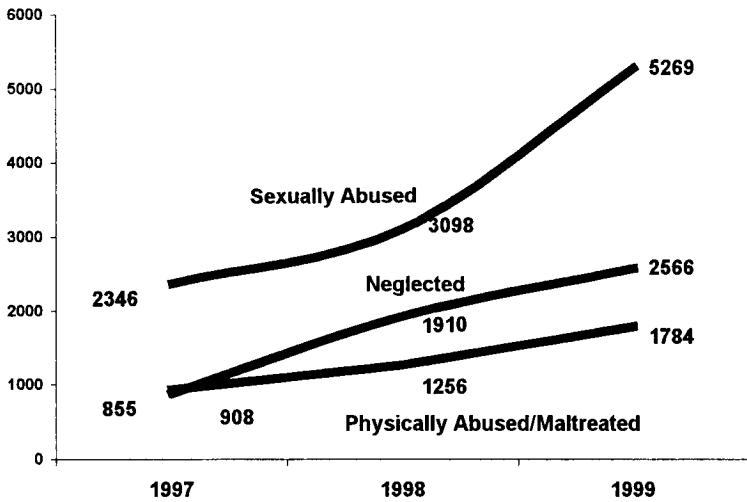

Source: Department of Social Welfare and Development

Table 43. Number of Human Rights Violations Handled by CHR-CRC by Classification of the Case, April 1994-June 1997

Classification of the Case	April 1994-June 1997	
	Number	Percent
Sexual Abuse	472	40.2
Rape/Attempted Rape	376	79.7
Acts of Lasciviousness	75	15.9
Sexual Harassment	11	2.3
Qualified Seduction	10	2.1
Physical Abuse	234	19.9
Physical Injures/Abuse	234	100.0
Threats to Life/Death	125	10.6
Murder/Homicide	111	88.8
Frustrated/Attempted Murder	14	11.2
Special Concerns	103	8.8
Youth Offender Cases	49	47.6
Streetchildren	7	6.8
Discrimination Cases	8	7.8
RA 7610	39	37.9
Traditional HRV	84	7.1
Illegal/Unlawful Detention	21	25.0
Illegal/Unlawful Arrest	24	28.6
Crossfire Victims	13	15.5
Harassment/Grave Threats	17	20.2
Abuse of Authority	6	7.1
Disappearance	3	3.6
Neglect	74	6.3
Parental Support	74	100.0
Others	83	7.1
Total	1175	100

Source: Commission on Human Rights-Child Rights Center

Table 44. Number of Human Rights Violations Handled by CHR-CRC by Classification of the Case, 1999

Classification of the Case	1999	
	Number	Percent
Sexual Abuse	28	40.6
Rape	18	64.3
Acts of Lasciviousness	7	25.0
Sexual Harassment	2	7.1
Prostitution	2	7.1
Exploitation	1	3.6
Special Concerns	10	14.5
Youth Offender Cases	7	70.0
Streetchildren	1	10.0
Involuntary Servitude	1	10.0
Child Labor	1	10.0
Physical Abuse	8	11.6
Physical Injuries/Abuse	8	100.0
Neglect	7	10.1
Parental Support	2	28.6
Abandonment	2	28.6
Custody	2	28.6
Adoption	1	14.3
Traditional HRV	6	8.7
Harassment	5	83.3
Torture	1	16.7
Threats to Life/Death	5	7.2
Murder	1	20.0
Frustrated/Attempted	1	20.0
Unlawful Detention	2	40.0
Homicide	1	20.0
Others	5	7.2
Total	69	100

Source: Commission on Human Rights-Child Rights Center

**Table 45. Number of Child Workers Rescued
by BWYW, 1993-1998**

Year	Child Workers Rescued
1993	20
1994	45
1995	64
1996	97
1997	94
1998	311

Source: Department of Labor and Employment-Bureau of Women and Young Workers

Figure 23. Number of Child Workers Rescued by BWYW, 1993-1998

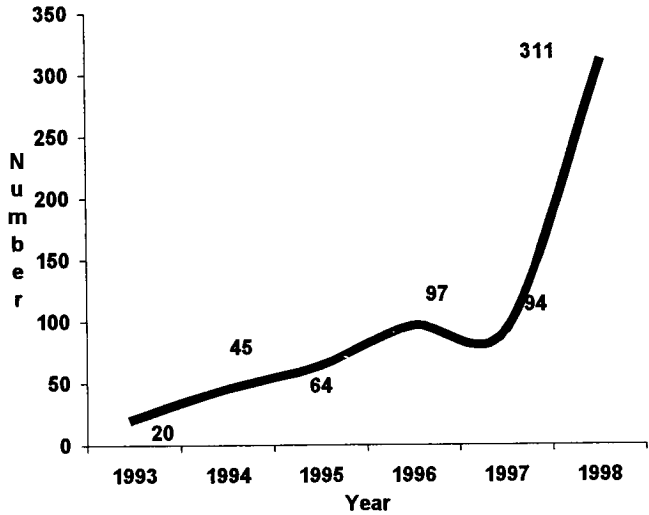

Source: Department of Labor and Employment-Bureau of Women and Young Workers

Table 46. Child Abuse Victims Reported to the PNP by Age Group, 1998-1999

Age Group of the Victim	Number of Cases	
	Number	Percent
1998		
13-17	2153	56.7
8-12	984	25.9
1-7	661	17.4
Total	3798	100
1999		
12-17	3386	58.8
6-11	1696	29.5
1-5	675	11.7
Total	5757	100

Note: 1998 and 1999 totals may not add up to 4392 and 6083, respectively, due to child abuse cases whose age of the victim were not stated in the in-take forms.

Source: Philippine National Police

Figure 24. Distribution of Child Abuse Victims Reported to the Police by Age Group, 1999 (In Percent)

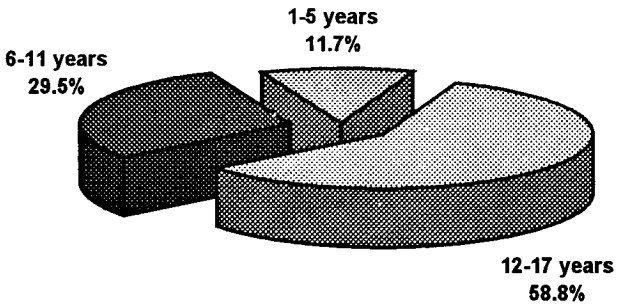

Source: Philippine National Police

Table 47. Child Abuse Victims Reported to the PNP by Age Group and by Region, 1999

Age Group	TOTAL	NCR	XII	VII	VI	IV
12-17	3386	346	359	277	434	144
6-11	1696	218	216	171	167	150
1-5	675	104	84	55	81	70
Total	5757	668	659	503	682	364

Note: Totals may not add up to 6083 due to child abuse cases whose age of the victim were not stated in the in-take forms.

Source: Philippine National Police

XI	III	V	X	VIII	CAR	IX	I	II	XIII	ARMM
315	297	180	241	179	162	134	166	102	36	14
146	132	97	85	73	73	56	53	29	22	8
56	43	37	42	18	22	23	19	13	7	1
517	472	314	368	270	257	213	238	144	65	23

**Table 48. Child Abuse Victims Reported
to the PNP by Sex, 1999**

Sex of Victim	1999	
	Number	Percent
Female	4304	77.9
Male	1224	22.1
Total	5528	100

Note: Total may not add up to 6083 due to child abuse cases whose sex of the victim were not stated in the in-take forms.

Source: Philippine National Police

Figure 25. Distribution of Child Victims Reported to the PNP by Sex, 1999

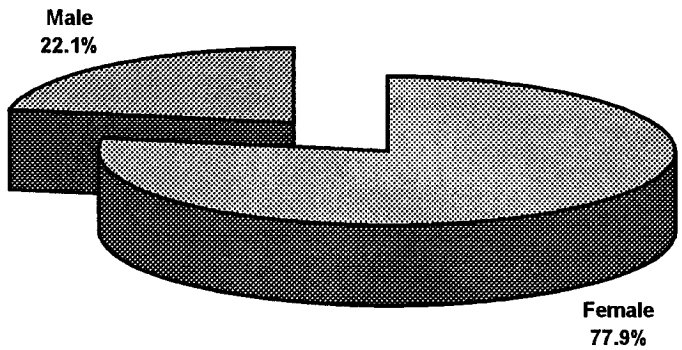

Source: Philippine National Police

Table 49. Child Abuse Victims Reported to the PNP by Sex and by Region, 1999

Sex of Victim	TOTAL	NCR	III	VII	XI	XII
Female	4304	422	418	417	415	404
Male	1224	165	49	115	138	132
TOTAL	5528	587	467	532	553	536

Note: Totals may not add up to 6083 due to child abuse cases whose sex of the victim were not stated in the in-take forms.

Source: Philippine National Police

VI	IV	V	X	viii	I	IX	CAR	II	XIII	ARMM
403	370	277	263	231	180	164	154	123	47	18
126	102	43	125	44	32	66	55	9	17	6
529	472	320	388	275	212	230	209	132	64	22

Table 50. Child Abuse Perpetrators Reported to the PNP by Age Group, 1999

Age Group of the Perpetrator	1999	
	Number	Percent
18-20	1054	20.3
21-25	916	17.6
26-30	808	15.6
31-35	624	12.0
36-40	521	10.0
41-45	395	7.6
46-50	282	5.4
51-55	202	3.9
56-60	180	3.5
61 and above	213	4.1
Total	5195	100

Note: Total may not add up to 6083 due to child abuse cases whose age of the perpetrator were not stated in the in-take forms.

Source: Philippine National Police

**Figure 26. Distribution of Child Abuse Perpetrators Reported to the PNP by Age Group, 1999
(In Percent)**

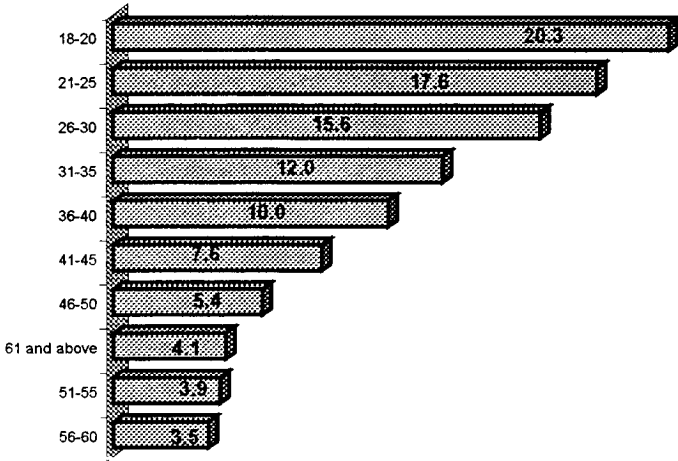

Source: Philippine National Police

Statistics on Child Abuse Victims and Perpetrators

Table 51. Child Abuse Perpetrators Reported to the PNP by Age Group and by Region, 1999

Age Group of the Perpetrator	TOTAL	XII	NCR	VI	VII	X
18-20	1054	131	124	120	112	100
21-25	916	116	117	104	62	49
26-30	808	107	116	77	73	45
31-35	624	63	101	71	59	25
36-40	521	46	75	58	62	35
41-45	395	33	59	50	29	23
46-50	282	36	25	36	26	23
51-55	202	24	28	24	20	10
56-60	180	9	20	20	15	11
61 and above	213	14	23	15	20	6
Total	5195	679	688	575	476	327

Note: Totals may not add up to 6083 due to child abuse cases whose age of the perpetrator were not stated in the in-take forms.

Source: Philippine National Police

XI	III	IV	CAR	V	IX	I	VIII	II	XIII	ARMM
99	75	56	52	48	44	34	26	20	10	3
80	77	91	30	55	41	26	35	22	9	2
68	62	61	33	43	27	18	39	25	8	6
54	37	58	43	29	18	21	26	12	5	2
52	40	49	17	14	13	26	21	2	9	2
43	38	40	14	12	8	18	14	8	4	2
13	24	26	8	17	8	6	23	5	5	1
17	14	13	6	19	7	9	7	3	1	...
17	25	14	5	8	4	9	12	6	4	1
21	5	30	16	15	5	19	14	6	4	...
464	397	438	224	260	175	186	217	109	59	19

**Table 52. Perpetrators of Child Abuse Cases
Reported to the PNP by Sex, 1999**

Sex of the Perpetrator	1999	
	Number	Percent
Male	4935	86.7
Female	754	13.3
Total	5689	100

Note: Total may not add up to 6083 due to child abuse cases whose sex of the perpetrator were not stated in the in-take forms.

Source: Philippine National Police

**Figure 27. Distribution of Perpetrators of Child Abuse Cases Reported to the PNP by Sex, 1999
(In Percent)**

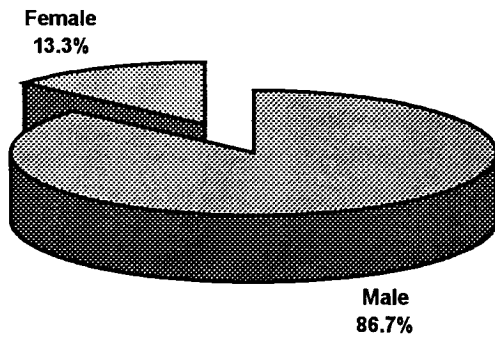

Source: Philippine National Police

Table 53. Perpetrators of Child Abuse Cases Reported to the PNP by Sex and by Region, 1999

Sex of the Perpetrator	TOTAL	VI	NCR	XI	XII	VII
Male	4935	579	549	495	477	472
Female	754	77	139	52	159	52
TOTAL	5689	656	688	547	636	524

Note: Totals may not add up to 6083 due to child abuse cases whose sex of the perpetrator were not stated in the in-take forms.

Source: Philippine National Police

III	IV	V	X	VIII	CAR	I	IX	II	XIII	ARMM
428	395	284	243	238	223	192	155	131	57	17
34	63	18	39	29	28	20	25	12	3	4
462	458	302	282	267	251	212	180	143	60	21

Table 54. Perpetrators of Child Abuse Cases Reported to the PNP by History of Substance Abuse, 1999

Substance Abuse	1999	
	Number	Percent
None	3123	69.4
Alcohol	902	20.0
Drugs	240	5.3
Both	237	5.3
Total	4502	100

Note: Total may not add up to 6083 due to child abuse cases whose history of substance abuse of the perpetrator were not stated in the in-take forms.

Source: Philippine National Police

Figure 28. Distribution of Perpetrators of Child Abuse Cases Reported to the PNP by History of Substance Abuse, 1999 (In Percent)

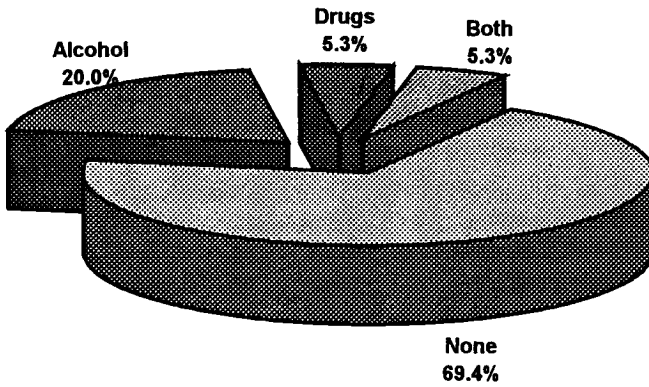

Source: Philippine National Police

Table 55. Perpetrators of Child Abuse Cases Reported to the PNP by History of Substance Abuse and by Region, 1999

Substance Abuse	TOTAL	NCR	XII	VI	XI	III
None	2923	451	353	347	301	275
Alcohol	892	97	91	113	62	73
Drugs	240	57	8	18	28	27
Both	231	16	107	28	1	5
Total	4286	621	559	506	392	380

Note: Totals may not add up to 6083 due to child abuse cases whose history of substance abuse of the perpetrator were not stated in the in-take forms.

Source: Philippine National Police

IV	VII	V	VIII	I	CAR	IX	II	X	XIII	ARMM
243	209	159	134	114	91	77	65	60	34	10
94	80	48	51	37	43	22	27	40	12	2
26	20	11	16	1		3	4	16	4	1
38	8	10	7	6	2			1	2	
401	317	228	208	158	136	102	96	117	62	13

ANNEXES

TASK FORCE TO GENERATE STATISTICS ON VIOLENCE AGAINST WOMEN AND CHILDREN

Chairperson: Ms. Carmelita N. Ericta
NSCB Asst. Secretary General

Co-Chairperson: Dir. Marina M. Tabamo, DSWD

Members:

Ms. Karen Gomez-Dumpit, CHR – CRC
Ms. Gemma F. Ifurung, CWC
Ms. Lolita Marfil, DILG
Ms. Ana Urmeneta, DILG
Ms. Nely O. Gamiao, DILG – BLGS
Ms. Diana M. Baldonado, DILG - BLGS
Dr. Erlinda T. Guerrero, DOH
Ms. Fe Sinson, DOH
Ms. Cecile Y. Brillantes, DOLE – BWYW
Ms. Alma P. Infante, DSWD
Dir. Lea Robidillo-Ortega, ECPAT
Ms. Dolores Alforte, ECPAT
Ms. Dalen Palami, HASIK
Ms. Donna Lynn A. Caparas, NAPOLCOM
Fiscal Erlinda Nicolas-Alvaro, NAPROS
Ms. Bernardita Matutina, NBI
Atty. Angelica Somera, NBI
Ms. Ferly Enriquez, NCRFW
Ms. Rose A. E. Nepomuceno, NCRFW
Ms. Anita E. Baleda, NCRFW
Ms. Katherine Firmeza, NEDA
Dr. Elizabeth M. Go, NSO
Ms. Paula Monina G. Collado, NSO
P/Sr. Insp. Ildebrandi N. Usana, PNP
P/Insp. Rhodora A. Maylas, PNP
Dr. Sylvia H. Guerrero, UPCWS

Dr. Bernadette Madrid, UP-PGH/CPU
Ms. May Panganiban, UP-PGH/CPU
Dr. Rosanna E. De Guzman, UP-PGH/WD
Ms. Belinda Jubilo-Santos, UP-PGH/WD
Ms. Salvacion B. Pascual, WCC

**PROJECT STAFF ON THE “DEVELOPMENT
OF A METHODOLOGY TO GENERATE STATISTICS
ON VIOLENCE AGAINST WOMEN AND CHILDREN”**

Project Management Committee

Chairperson:	SG Romulo A. Virola
Vice-Chairperson:	ASG Carmelita N. Ericta
Members:	Dir. Francisco K. Mallion ADir. Lina V. Castro Teresita B. Deveza

Project Technical Staff

Project Manager:	Lina V. Castro Teresita B. Deveza
Assistant Project Manager:	Redencion M. Ignacio

Concepts/Framework Team

Team Leader:	Virginia N. Gañac
Senior Technical Staff:	Raquel Susan V. Obedoza
Technical Staff:	Marietta V. Gumela Jessamyn O. Encarnacion

Reporting System/Estimation Team

Team Leader:	Teresita B. Deveza
Senior Technical Staff:	Redencion M. Ignacio
Technical Staff:	Laodicea F. Delos Santos Eileen P. Capilit Marymell A. Martillan

NCRFW Officials and Technical Staff

Executive Director:	Ermelita V. Valdeavilla
OIC-Deputy Executive Director: Chief, Information and Resource Division:	Eufrosina O. Dumlao
Planning Officer IV:	Ferly P. Enriquez Rose Asuncion E. Nepomuceno
Information Officer III: Statistician II:	Anita E. Baleda Agnes I. Dichoso

NCRFW-CIDA ISP II Project Management Staff

Project Manager:	Sarah N. Umandal
Assistant Project Manager for Administrative & Finance:	Eduardo S. Layag
Assistant Project Manager for Technical Operations: Project Monitoring Officer:	Miriam M. Buergo Precy A. Platon-Tica

Project Technical Consultants

Cielito F. Habito, NEDA
 Lina B. Laigo, DSWD
 Ofelia C. Templo, NEDA
 Estrella V. Domingo, NSCB
 Margarita F. Guerrero, NSO
 Divina P. Caalim, CWC
 Mercedes B. Concepcion, UPPI
 Lisa Grace Bersales, UPSC
 Corazon M. Raymundo, UP
 Solita C. Monsod, UPSE
 Benjamin Diokno, UPSE
 Virginia A. Miralao, PSSC
 Carol Sobritchea, UPCWS

NATIONAL STATISTICAL COORDINATION BOARD

DR. ROMULO A. VIROLA
Secretary General

ESTRELLA V. DOMINGO
Officer-in-Charge
Assistant Secretary General

FRANCISCO K. MALLION
Director, SPRMO

LINA V. CASTRO
Asst. Director, SPRMO

TERESITA B. DEVEZA
Chief, SSD

REDENCION M. IGNACIO
Assistant Chief, SSD

SSD Sector Specialists/Staff
RAQUEL SUSAN V. OBEDOZA
EILEEN P. CAPILIT
MARIETTA V. GUMELA
LAODICEA F. DE LOS SANTOS
JESSAMYN O. ENCARNACION
MARYMELL A. MARTILLAN

PROJECT STAFF ON THE "DEVELOPMENT OF A METHODOLOGY TO GENERATE STATISTICS ON VIOLENCE AGAINST WOMEN AND CHILDREN"

Project Management Committee

Chairperson: SG Romulo A. Virola
Vice-Chairperson: ASG Carmelita N. Ericta
Members: Dir. Francisco K. Mallion
ADir. Lina V. Castro
Teresita B. Deveza

Project Technical Staff

Project Manager: Lina V. Castro
Teresita B. Deveza
Assistant Project Manager: Redencion M. Ignacio

Concepts/Framework Team

Team Leader: Virginia N. Gañac
Senior Technical Staff: Raquel Susan V. Obedoza
Technical Staff: Marietta V. Gumela
Jessamyn O. Encarnacion

Reporting System/Estimation Team

Team Leader: Teresita B. Deveza
Senior Technical Staff: Redencion M. Ignacio
Technical Staff: Laodicea F. Delos Santos
Eileen P. Capilit
Marymell A. Martillan



OTHER NSCB PUBLICATIONS

- ◆ Statistical Handbook on Women and Men in the Philippines, 1999
- ◆ Report on the Philippine Human Development Index, 1997
- ◆ Statistical Report on Children and Women, 1992
- ◆ Poverty Statistics, 1997
- ◆ National Accounts of the Philippines
- ◆ Gross Regional Domestic Product, 199-1999
- ◆ Gross Regional Domestic Expenditure, 1995-1997
- ◆ Input-Output, 1994
- ◆ Philippine Statistical Yearbook, 2000
- ◆ Dictionary of Selected Statistical Terms
- ◆ Manual on the Preparation of Statistical Project Proposals
- ◆ Philippine Standard Commodity Classification, Rev.2 1993
- ◆ Regional Social and Economic Trends (RSET), 1998
 - Region I (RSET 1)
 - Region V (RSET 5)
 - Region VI (RSET 6)
 - Region VIII (RSET 8)
 - Region IX (RSET 9)
 - Region XII (RSET 12)
- ◆ Gateway to Metro Manila, 2000
- ◆ Inventory of Ports (as of December 1998)
- ◆ Inventory of Airports (as of January 1999)
- ◆ Food Balance Sheet of the Philippines: 1997-1999
- ◆ Sixth National Convention on Statistics: 1996
- ◆ The Countryside in Figures, 2000
- ◆ 7th National Convention on Statistics Volume I and Volume II, 1999
- ◆ Asian Regional Section, International Conference on Statistical Computing, 1998
- ◆ Catalogue of Philippine Statistical Publications
- ◆ Profile of Censuses and Surveys Conducted by the Philippine Statistical System, 2000
- ◆ Directory of Statistical Services in the Philippines, 1999
- ◆ Factsheets
- ◆ NSCB Statistics Series
- ◆ Statwatch

NATIONAL STATISTICAL COORDINATION BOARD

DR. ROMULO A. VIROLA
Secretary General

ESTRELLA V. DOMINGO
Officer-in-Charge
Assistant Secretary General

FRANCISCO K. MALLION
Director, SPRMO

LINA V. CASTRO
Asst. Director, SPRMO

TERESITA B. DEVEZA
Chief, SSD

REDENCION M. IGNACIO
Assistant Chief, SSD

SSD Sector Specialists/Staff
RAQUEL SUSAN V. OBEDOZA
EILEEN P. CAPILIT
MARIETTA V. GUMELA
LAODICEA F. DELOS SANTOS
JESSAMYN O. ENCARNACION
MARYMELL A. MARTILLAN

Visit us at www.nscb.gov.ph